

ULTRA
SERIES

AES

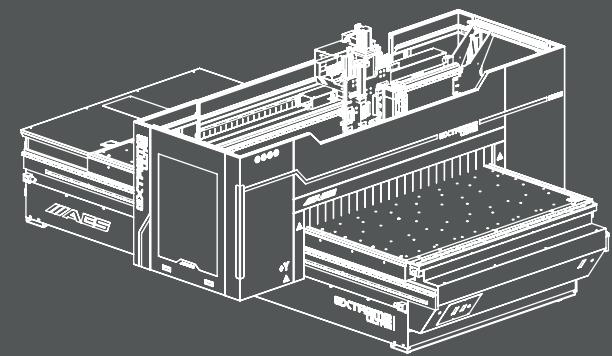

EXTREME
ULTRA



EN
TR
ES

Making its first overseas investment in the USA as the flagship of the Turkish woodworking machinery industry, AES continues to serve its customers in the North and South America through its center that was launched in Charlotte, North Carolina to provide sales and aftersales services.

Türk ahşap işleme sektörünün bayrak taşıyıcı firması olarak, ABD'de ilk yurt dışı yatırımını yapan AES satış ve satış sonrası hizmetleri için N.Carolina/Charlotte'da aktif hale getirdiği merkezi ile, Kuzey ve Güney Amerika'da hizmet vermeyi sürdürmektedir.

Haciendo su primera inversión en el extranjero en los EE. UU. como el buque insignia de la industria de maquinaria de carpintería turca, AES continúa sirviendo a sus clientes en América del Norte y del Sur a través de su centro que se inauguró en Charlotte, Carolina del Norte para brindar servicios de ventas y posventa.

As part of its policy to expand its sales and aftersales service network on an ongoing basis, AES has incorporated its affiliate AES Europe in Bilzen, Belgium with a view to providing better sales and aftersales services as well as technical support to its customers in Europe

Avrupa kıtasındaki müşterilerine daha iyi satış ve satış sonrası hizmet verebilmek amacıyla Bilzen/Belçika'da AES Europe'u kurdu. AES, müşterilerine teknik destek sağlarken satış ve servis ağını da her geçen gün büyümeye devam etmektedir.

Con el fin de brindar un mejor servicio de venta y posventa a sus clientes en el continente europeo, AES que estableció AES Europe en Bilzen/Bélgica, mientras brinda soporte técnico a sus clientes, continúa expandiendo su red de ventas y servicio día a día.

AES GROUP, which has redefined the sector with the machines and designs it has developed in the Woodworking Machinery sector since the first day it was founded in 1989; it is the flag carrier company of Turkey in the sector. AES, which always continues to be your global partner with its high production capacity, expert staff, global sales and service network, grows with you and continues to develop while growing, with the centers it opened and the service network it established to become one of the world's leading manufacturers in line with its founding vision.

1989 yılında, kurulduğu günden bu yana Ahşap İşleme Makineleri sektöründe geliştirdiği makineler ve tasarımlarla sektörü yeniden tanımlayan AES GROUP; Türkiye'nin sektördeki bayrak taşıyıcı firması konumundadır. Yüksek üretim kapasitesi, uzman kadrosu, küresel satış ve servis ağı ile her zaman global partneriniz olmaya devam eden AES, kuruluş vizyonu doğrultusunda, dünyanın sayılı üreticileri arasında girmek için açtığı merkezler ve kurduğu hizmet ağı ile; sizlerle büyüyor, büyürken de geliştirmeye devam ediyor.

GRUPO AES, que ha redefinido el sector con las máquinas y diseños que ha desarrollado en el sector de la Maquinaria para la Madera desde el primer día de su fundación en 1989; Es la compañía aérea de bandera de Turquía en el sector. AES, que siempre sigue siendo su socio global con su alta capacidad de producción, personal experto, red global de ventas y servicio, crece con usted y continúa desarrollándose mientras crece, con los centros que abrió y la red de servicio que estableció para convertirse en uno de los principales fabricantes del mundo en consonancia con su visión fundacional.

your global partner

AES Group: It grows with you with the goal of becoming a global brand and continues to produce and develop while growing. AES UK continues its Sales and After-Sales Service services in the UK, Ireland, Northern Ireland, Scotland and Wales regions.

AES Group; küresel bir marka olma hedefi ile sizlerle büyümekte, büyürken de üretmeye ve geliştirmeye devam etmektedir. AES UK firması ile Britanya, İrlanda, Kuzey İrlanda, İskoçya ve Galler bölgelerinde Satış ve Satış Sonrası Servis hizmetlerini sürdürmektedir.

Grupo AES; Crece contigo con el objetivo de convertirse en una marca global y continúa produciendo y desarrollándose mientras crece. AES UK continúa con sus servicios de Ventas y Servicio Posventa en las regiones del Reino Unido, Irlanda, Irlanda del Norte, Escocia y Gales.

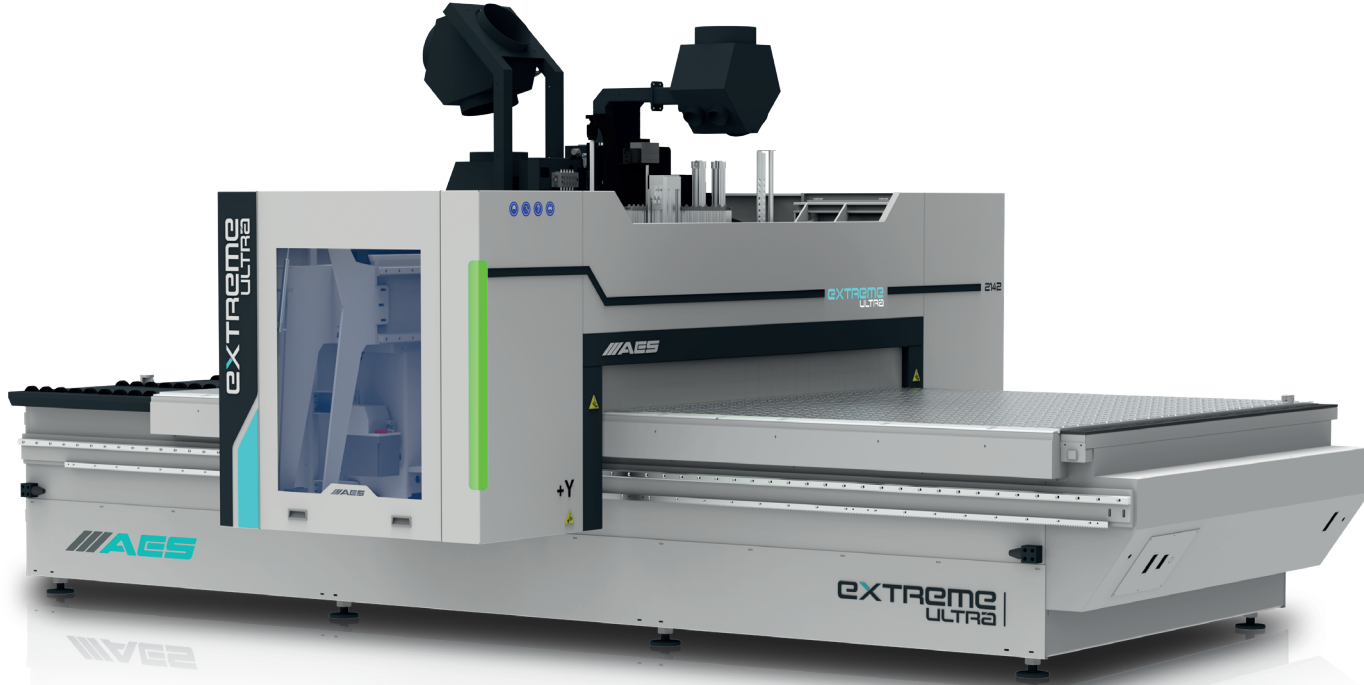

1325
1300x2500mm

1336
1300x3700mm

1632
1600x3200mm

1640
1600x4000mm

2128
2100x 2800mm

2132
2100x 3200mm

2136
2100x 3700mm

2142
2100x 4200mm

UltraPower

Performance

Ultra güç, ultra performans
Ultra potencia Ultra rendimiento

EN

Our ULTRA series machinery offers industrial solutions to provide maximum performance even for the most delicate designs and processes. The ULTRA series will support you for all your needs with its flexible configuration, optimizing operation speed and precision thanks to its gantry system allowing for excellent acceleration. It ensures that you achieve the best machining results you could imagine thanks to its body structure eliminating even the slightest vibrations.

TR

Endüstriyel çözümler sunan ULTRA serisi makinelerimiz ile en hassas tasarım ve işlemlere dahi tam performans çözümler sunar. Esnek konfigürasyonu sayesinde tüm ihtiyaçlarınız için yanınızda olan ULTRA serisi; Gantry sistemi ile makine çalışma hızı ve hassasiyetini optimum seviyeye çıkararak mükemmel ivmelenmeye olanak sağlar. En küçük vibrasyonun dahi engellendiği gövde yapısı sayesinde işleme esnasında size hayalinizdeki sonucu garanti eder.

ES

Con nuestras máquinas de la serie ULTRA que ofrecen soluciones industriales, ofrecemos soluciones de rendimiento completo incluso para los diseños y procesos más sensibles. Gracias a su configuración flexible, el sistema Gantry de la serie ULTRA, que le apoya para todas sus necesidades, proporciona una excelente aceleración al optimizar la velocidad de trabajo y la precisión de la máquina. Gracias a su estructura del cuerpo que evita hasta la mínima vibración, le garantiza el resultado de sus sueños durante el procesamiento.



The Answer of Extreme^{of} Needs

Performs your nesting and drilling applications faster with higher precision thanks to its sturdy body construction and advanced configuration. It performs loading and unloading operations automatically in the fully automated production line mode. Offers high-end solutions to mass manufacturing companies by increasing productivity.

Güçlü gövde yapısı ve gelişmiş konfigürasyonu ile, nesting ve delik uygulamalarında olduğundan daha hızlı, daha hassas gerçekleştirilir. Tam otomatik yükleme boşaltma işlemlerini otomatik yapar. Üretimde verimliliği artırarak seri üretim yapan firmalar için üst seviye çözümler sunar.

Con su sólida estructura de cuerpo y configuración avanzada, se realiza con mayor rapidez y precisión en comparación con las aplicaciones de nesting y perforación. Realiza operaciones de carga y descarga totalmente automáticas. Ofrece soluciones de alto nivel para empresas dedicadas a la producción en serie aumentando la eficiencia en la producción.



Maximum Productivity

Maksimum üretkenlik
Máxima productividad

BORING UNIT

ÇOKLU DELİK ÜNİTESİ

UNIDAD DE ORIFICIOS MÚLTIPLES

EN

Shorten your lead time with customized drilling unit options

TR

İhtiyaçlarınıza göre şekillendirilebilen delik ünitesi seçenekleri ile üretim sürecinizi kısaltın.

ES

Acorte su proceso de producción con opciones de unidades de orificios que pueden moldearse según sus necesidades.

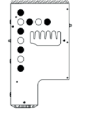
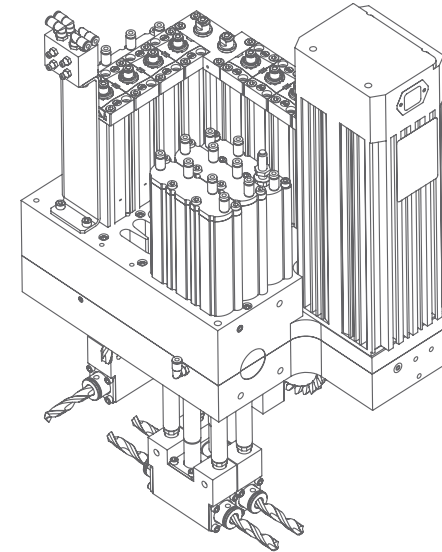

10V

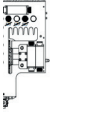

10V - 3x2H - 1 S

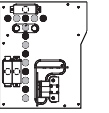

14V - 3x2H - 1 S

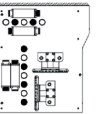

12V - 4x2H - 2 S



18V

HIGH SPEED & PRECISION

YÜKSEK HIZ - YÜKSEK HASSASİYET

ALTA VELOCIDAD Y ALTA PRECISIÓN

EN

High quality spindle motor ensures the best results with high speed and maximum precision in all machining applications, including 3D.

TR

Yüksek kaliteli spindle motoru, 3D dahil tüm işleme uygulamalarında yüksek hız ve maksimum hassasiyetle en iyi sonuçları almanızı sağlar.

ES

El motor de husillo de alta calidad garantiza los mejores resultados con alta velocidad y máxima precisión en todas las aplicaciones de mecanizado, incluido el 3D.

EXTENDED AGGREGATE USAGE AREA

AGGREGATE İLE GENİŞ KULLANIM ALANI

UNIDAD CAMBIADOR DE HERRAMIENTAS MOVILES

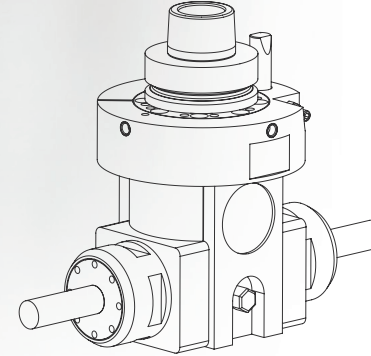

PROFESSIONAL VACUUM EQUIPMENT

PROFESYONEL VAKUM EKİPMANLARI

EQUIPOS DE VACÍO PROFESIONAL

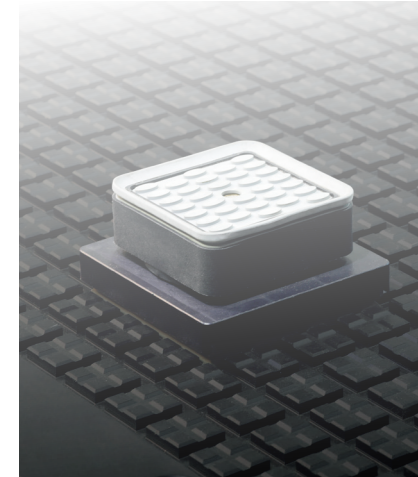

CENTRAL LUBRICATION UNIT
Lubricates the machine at 21 different lubrication points automatically.

MERKEZİ YAĞLAMA ÜNİTESİ
21 farklı bölgede otomatik olarak yağlama sağlar.

UNIDAD CENTRAL DE LUBRIFICACIÓN
Proporciona lubricación automática en 21 regiones diferentes.



AXIS CONTROL WITH SERVO MOTORS
State of the art motors located on each axis ensure precise acceleration at high speed.

SERVO MOTORLAR İLE EKSEN KONTROLÜ
Tüm eksenlerde bulunan son teknoloji üniteli motorlar, yüksek hızlarda hassas ivmelenme sağlar.

CONTROL DE EJES CON SERVOMOTORES
Los motores de última generación en todos los ejes proporcionan una aceleración precisa a altas velocidades.



HIGH-QUALITY RACK & RAIL
Low-vibration, dynamic & high quality rails and kreamayer are used to provide the best results at high speeds.

YÜKSEK KALİTE KREMAVER VE RAY
Yüksek hızlarda en iyi sonuç için düşük titreşim sağlayan dinamik, yüksek kaliteli ray ve kremayerler kullanılmaktadır.

CALIDAD EXCELENTE CARRIL DE CREMALLERA
Inin vibraciones bajas para mejores resultados a altas velocidades. Se utilizan rieles y racks dinámicos y de alta calidad. Estructura corporal.



VACUBOOST

Where the Spindle there is Power

Spindle nerede güç orada
Donde esta Spindle allí está la potencia

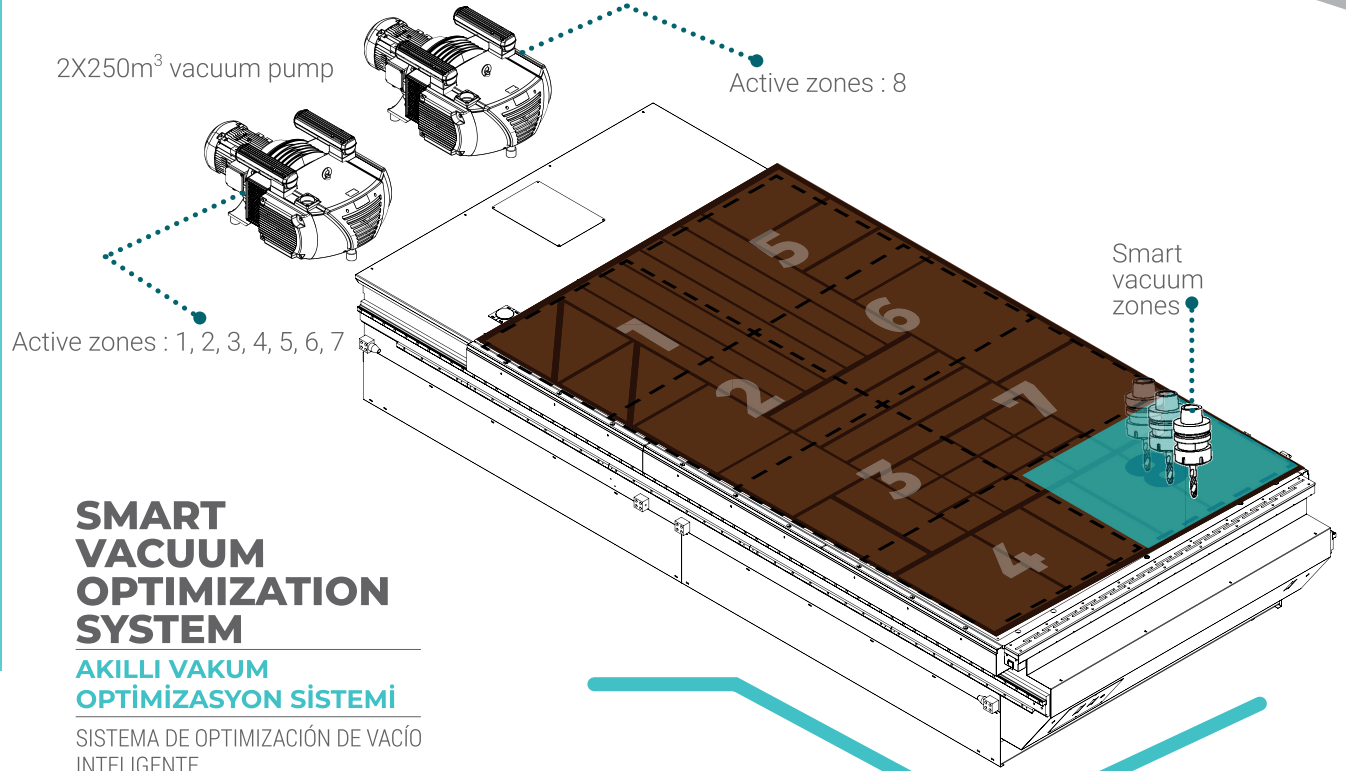

SMART VACUUM OPTIMIZATION SYSTEM

AKILLI VAKUM OPTİMİZASYON SİSTEMİ

SISTEMA DE OPTIMIZACIÓN DE VACÍO
INTELIGENTE

EN Our proprietary VACUBOOST technology, focusing on the position of the vacuumed work part for unrivalled gripping power, has been developed to enable you to machine small work parts or porous materials such as chipboards easily.

TR Küçük parçalara veya sunta gibi geçirgen malzemeleri rahatlıkla işleyebilmeniz için geliştirdiğimiz patentli VACUBOOST teknolojisi ile vakumlanan parçanın konumuna odaklanarak benzersiz bir tutuş gücü sağlar.

ES Proporciona un poder de agarre único al centrarse en la posición de la pieza aspirada con la tecnología patentada VACUBOOST que hemos desarrollado para que pueda procesar fácilmente piezas pequeñas o materiales permeables como la madera aglomerada.

HIGH -EFFICIENCY VACUUM PUMP

GÜÇLÜ VAKUM POMPASI

POTENTE BOMBA DE VACÍO

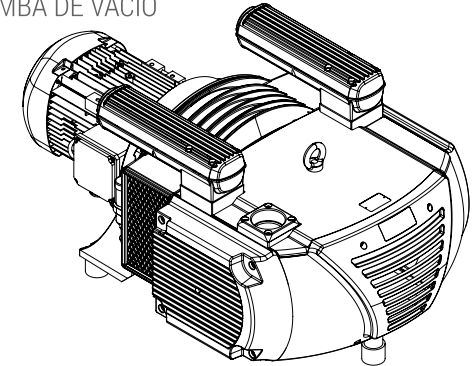

Every Second Counts

Her Saniyeniz Değerli
Cada segundo es valioso

ROTARY MAGAZINE UNIT

HAREKETLİ TAKIM DEĞİŞTİRME ÜNİTESİ

UNIDAD PARA CAMBIAR DE
EQUIPOS MOVIBLE

EN

Quickly change tools with the rotary magazine to shorten machining time

TR

Hareketli takım değiştirme ünitesi ile kolay ve hızlı takım geçişi sağlayarak işleme sürenizi kısaltır.

ES

Reduce el tiempo de procesado al proporcionar un cambio de herramienta fácil y rápido con su unidad de cambio de herramienta móvil.

ES

Mientras que el indicador LED de estado de la máquina muestra el proceso de mecanizado de la máquina, los colores del indicador aumentan la seguridad del operador al siguiente nivel.

EN

While the machine led status indicator shows the machining process of the machine, the colors on the indicator increase operator safety to the next level.

TR

Makine led durum göstergesi makinenin işleme sürecini gösterirken, göstergede bulunan renkler ile operatör güvenliğini üst seviyeye çıkarır

MACHINE LED STATUS

MAKİNE LED GÖSTERGE

ESTADO DEL LED DE LA MÁQUINA



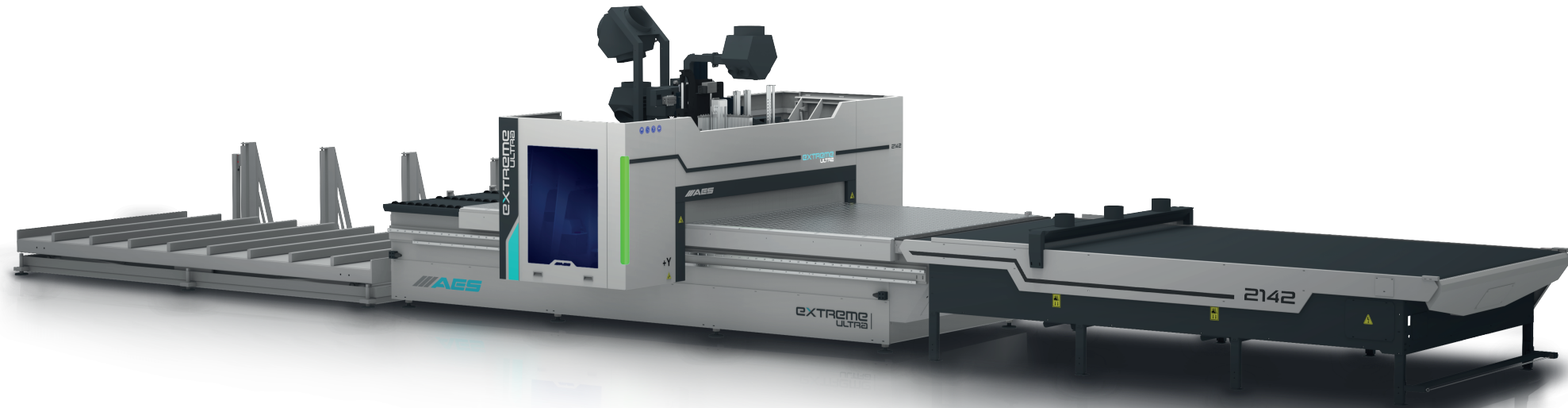
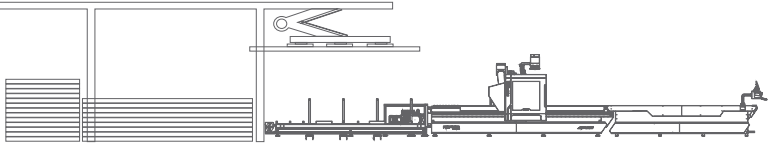

1325
1300x2500mm

1336
1300x3700mm

1632
1600x3200mm

1640
1600x4000mm

2128
2100x 2800mm

2132
2100x 3200mm

2136
2100x 3700mm

2142
2100x 4200mm

Ultra Power Performance

Ultra güç, ultra performans
Ultra potencia Ultra rendimiento

EN

Our ULTRA series machinery offers industrial solutions to provide maximum performance even for the most delicate designs and processes. The ULTRA series will support you for all your needs with its flexible configuration, optimizing operation speed and precision thanks to its gantry system allowing for excellent acceleration. It ensures that you achieve the best machining results you could imagine thanks to its body structure eliminating even the slightest vibrations.

TR

Endüstriyel çözümler sunan ULTRA serisi makinelerimiz ile en hassas tasarım ve işlemlere dahi tam performans çözümler sunar. Esnek konfigürasyonu sayesinde tüm ihtiyaçlarınız için yanınızda olan ULTRA serisi; Gantry sistemi ile makine çalışma hızı ve hassasiyetini optimum seviyeye çıkararak mükemmel işlemelerine olanak sağlar. En küçük vibrasyonun dahi engellendiği gövde yapısı sayesinde işleme esnasında size hayalinizdeki sonucu garanti eder.

ES

Con nuestras máquinas de la serie ULTRA que ofrecen soluciones industriales, ofrecemos soluciones de rendimiento completo incluso para los diseños y procesos más sensibles. Gracias a su configuración flexible, el sistema Gantry de la serie ULTRA, que le apoya para todas sus necesidades, proporciona una excelente aceleración al optimizar la velocidad de trabajo y la precisión de la máquina. Gracias a su estructura del cuerpo que evita hasta la mínima vibración, le garantiza el resultado de sus sueños durante el procesamiento.



Standalone



Semi Automatic Line



Full Automatic Line

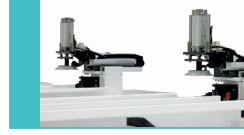

AUTOMATIC ALIGNMENT SYSTEM

OTOMATİK HİZALAMA SİSTEMİ

SISTEMA DE ALINEACIÓN AUTOMÁTICA

02.

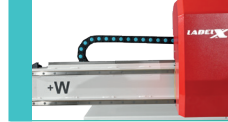

LABEL X AUTOMATIC LABELLING SYSTEM

OTOMATİK ETİKETLEME SİSTEMİ

SISTEMA DE ETIQUETADO AUTOMÁTICO

03.



LOADING UNIT

YÜKLEME ÜNİTESİ

UNIDAD DE CARGA

04.

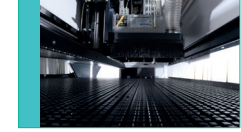

UNLOADING & CLEANING UNIT

BOŞALTIMA & TEMİZLEME ÜNİTESİ

UNIDAD DE DESCARGA Y LIMPIEZA

05.

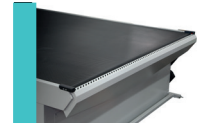

CONVEYOR UNIT

KONVEYÖR ÜNİTESİ

UNIDAD TRANSPORTADORA

06.



LIFT UNIT

LİFT ÜNİTESİ

UNIDAD DE ELEVACIÓN

01.



MANUAL LABELLING SYSTEM

MANUAL ETİKETLEME SİSTEMİ

SISTEMA DE ETIQUETADO MANUAL

07.

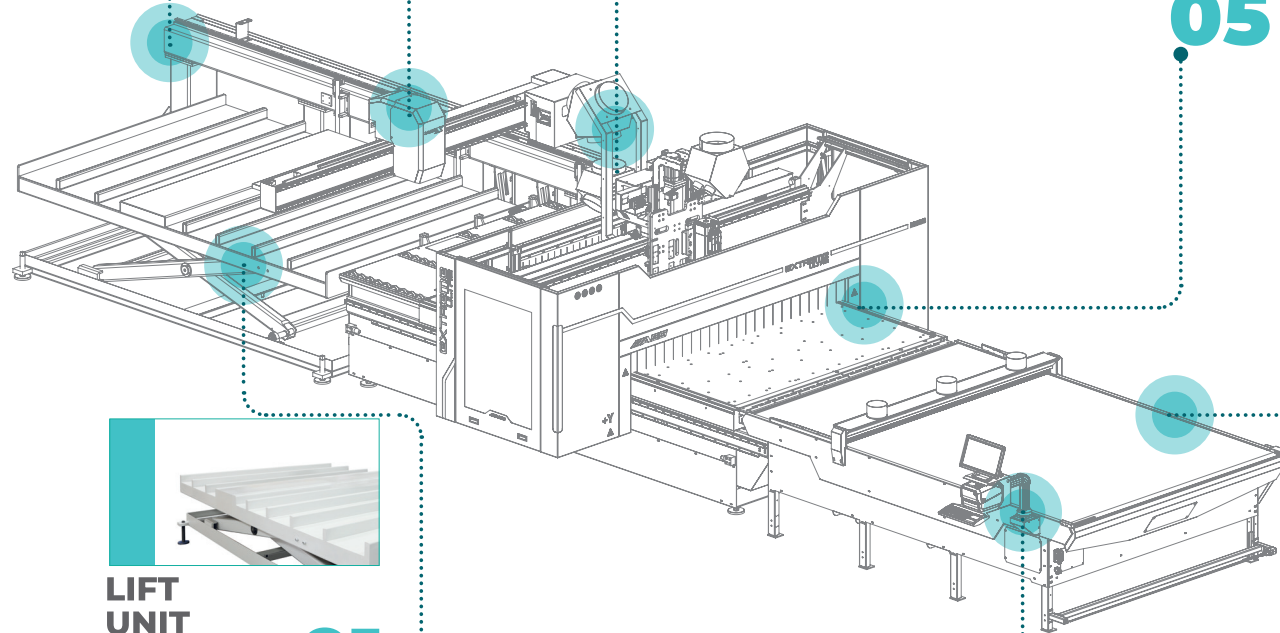

Groundbraking
production line
that has
changed
dynamics the
of the sector

Sektörün dinamiklerini değiştiren üretim hattı
La línea de producción que cambia la dinámica de la industria



NEXT GENERATION CNC CONTROL UNIT

YENİ JENERASYON CNC KONTROL ÜNİTESİ

UNIDAD DE CONTROL CNC DE ÚLTIMA GENERACIÓN

EN

The next generation control unit is powered by a PC designed for industrial operations. It allows you to make your transactions quickly and easily without getting stuck.

TR

Endüstriyel işler için üretilen PC'den gücünü alan yeni jenerasyon kontrol ünitesi. İşlemlerinizi takılmadan, hızlı ve kolay gerçekleştirmenizi sağlar.

ES

Unidad de control de nueva generación alimentada por PC fabricada para trabajos industriales. Le permite realizar sus transacciones de forma rápida y sencilla sin quedarse atascado.

EASY TO USE INTERFACE

KULLANIMI KOLAY ARAYÜZ

INTERFAZ FÁCIL DE USO



USER EXPERIENCE / KULLANICI DENEYİMİ / EXPERIENCIA DE USUARIO



"As easy to use as a mobile phone"

"Telefon kullanmak kadar kolay."

"Tan fácil como usar un teléfono"

"The machine helps us to perform machining operations accurately by guiding us with warning messages."

"Uyarılar bizi yönlendirerek, doğru işlem yapmamıza destek oluyor."

"Las alertas nos orientan y nos ayudan a realizar la acción correcta."

Our aftersales support team is always there for you when you need them thanks to the remote control feature of EXTREME ULTRA.

EXTREME ULTRA'ın uzaktan kontrol özelliği ile, ihtiyaç duyduğunuz her an satış sonrası destek ekibimiz yanınızda.

Gracias a la función de control remoto de EXTREME ULTRA, nuestro equipo de soporte posventa le apoya siempre que lo necesite.



7

LANGUAGE 7 DİL SEÇENEĞİ OPCIONES DE 7 IDIOMAS

TR / EN / AR / RU / ES / FR / NL

MAXIMUM SAFETY

MAKSİMUM GÜVENLİK

MÁXIMA SEGURIDAD

EN

The safety options of EXTREME ULTRA were designed to prevent unauthorized access to the work area with a view to maximizing safety of life. These safety options which are designed in compliance with the CE norms will minimize the risk of occupational accidents in your manufacturing processes.

TR

EXTREME ULTRA 'nin güvenlik opsiyonları çalışma alanına yetkisiz girişleri engelleyerek maksimum can güvenliği sağlamak için tasarlanmıştır. CE normlarına uygun şekilde hazırlanan güvenlik opsiyonları ile imalat süreçlerinizde iş kazası risklerini minimize eder.

ES

Las opciones de seguridad de EXTREME ULTRA están diseñadas para brindar la máxima seguridad humana al evitar el acceso no autorizado a la zona de trabajo. Minimiza los riesgos de accidentes laborales en sus procesos de fabricación con opciones de seguridad preparadas de acuerdo con normativa CE.

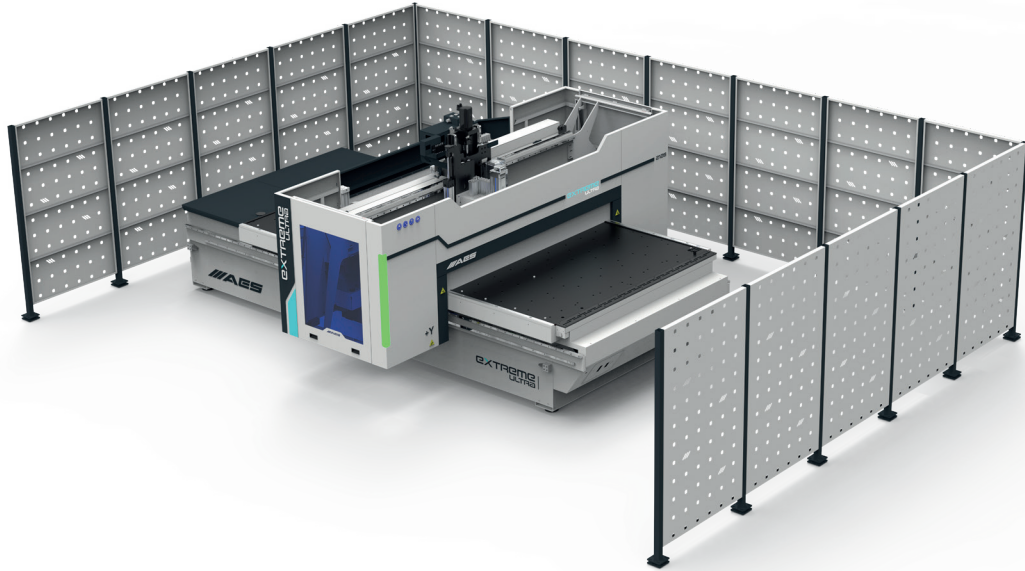

Safety Mats

Güvenlik Paspası
Felpudo de Seguridad

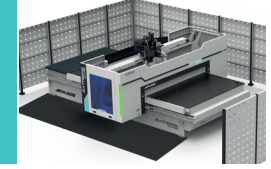

Light Barriers

Işık Bariyeri
Barrera de Luz

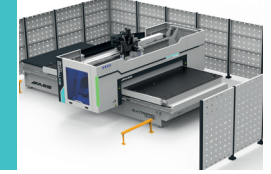

Safety Fences

Güvenlik Çiti
Valla de Seguridad

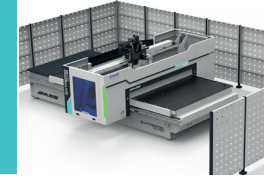

Bumpers

Bumper
Parachoques

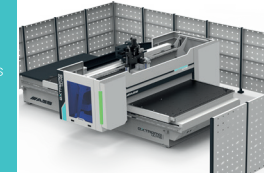

Area Scanning

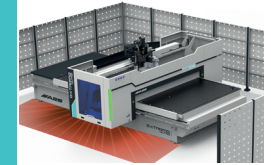

Alan Tarama
Escaneo de la zona





AW

AES WOP

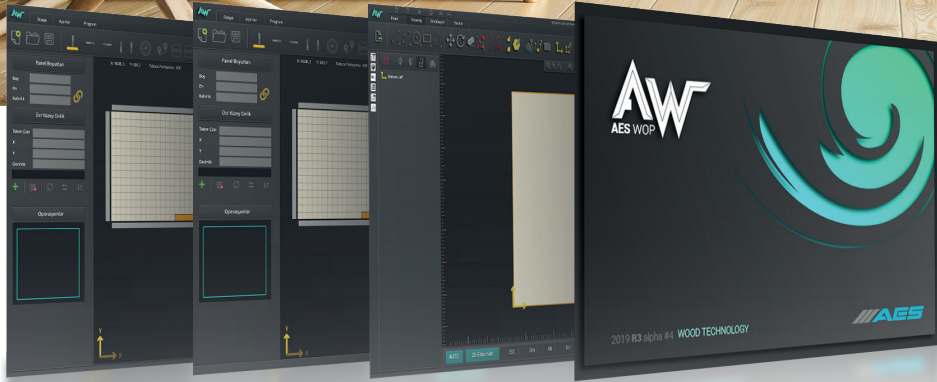
Design freely



RENDER
RENDER AL
GRÁFICOS



OPTIMIZE
OPTİMİZE ET
OPTIMIZAR



PRODUCT BLASTING & ASSEMBLY DRAWING
ÜRÜN
PATLATMA VE MONTAJ
RESMİ
EXPLOSIÓN E
INSTALACIÓN DE
PRODUCTOS



ACCESSORY LIBRARY
AKSESUAR
KÜTÜPHANESİ
BIBLIOTECA DE
ACCESORIOS

SIMPLY CREATE SMART DESIGNS

**BASİTÇE, AKILLI
TASARIMLAR OLUŞTURUN**

SIMPLEMENTE, CREE
DISEÑOS INTELIGENTES

EN

Due to its systemic parametric structure, the design can be changed automatically according to the desired and connection type. Create your designs, save them in the library and customize as needed.

TR

Sistemsel parametrik yapısı sayesinde yapılan tasarımlar istenilen ölçüye ve bağlantı türüne uygun şekilde otomatik olarak değiştirilebilir. Tasarımlarınızı oluşturun ve kütüphaneye kayıtlı edin. İhtiyaç duyduğunuz anda uyarlayın.

ES

Gracias a su estructura paramétrica del sistemática, los diseños se pueden cambiar automáticamente de acuerdo con el tamaño y el tipo de conexión deseados. Cree sus diseños y guárdelos en la biblioteca en el momento que los necesite.



**DESIGN
TASARLA
DISEÑO**



**TRANSFER
TRANSFER ET
TRANSFERIR**



**PRODUCE
ÜRET
PRODUCCIÓN**

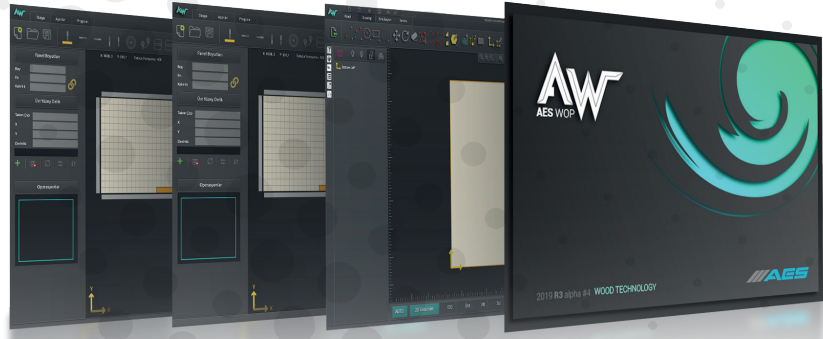

The Fastest way from Design to Manufacturing

TASARIM DAN ÜRETİME EN HIZLI YOL
LA RUTA MÁS RÁPIDA DEL DISEÑO HASTA LA PRODUCCIÓN



EN

AES WOP CAD/CAM program is designed to meet all your design needs. Its easy-to-use interface and advanced features allow you to prepare flexible and fully functional designs. It can be used in a wide range of areas, from design to part position changes, from workpiece definition to 3D simulation, tool path optimization and parametric use. Turn your designs into reality thanks to the software that works fully compatible with the machine.

TR

AES WOP CAD/CAM programı tüm tasarım ihtiyaçlarınızı karşılayacak şekilde tasarlanmıştır. Kullanımı kolay arayüzü ve gelişmiş özellikleri, esnek ve tam işlevsel tasarımlar hazırlamanızı sağlar. Tasarımdan parça pozisyon değişimlerine, çalışma parçası tanımlamadan 3D simülasyon ve takım yolu optimizasyonu ile parametrik kullanıma kadar çok geniş bir alanda kullanılabilir. Makine ile tam uyumlu çalışan yazılım sayesinde tasarımlarınızı gerçeğe dönüştürün.

ES

El programa CAD/CAM AES WOP está diseñado para satisfacer todas sus necesidades de diseño. Su interfaz fácil de usar y sus funciones avanzadas le permiten preparar diseños flexibles y completamente funcionales. Se puede utilizar en una amplia gama de áreas, desde el diseño hasta los cambios de posición de la pieza, desde la definición de la pieza de trabajo hasta la simulación 3D, la optimización de la trayectoria de la herramienta y el uso paramétrico. Convierte tus diseños en realidad gracias al software que funciona totalmente compatible con la máquina.



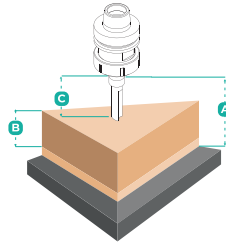

| CUTTING HEAD KESİM YÜKSEKLİĞİ ALTO DE CORTE | EXTREME ULTRA | | |
|---|---------------|------------|------------|
| | A | B | C |
| mm / inch | 395 / 15.5 | 200 / 7.87 | 170 / 6.69 |

TECHNICAL INFORMATION

TEKNİK ÖZELLİKLER

ESPECIFICACIONES TÉCNICAS

| TECHNICAL INFORMATION TEKNİK ÖZELLİKLER ESPECIFICACIONES TÉCNICAS | EXTREME ULTRA | | | | | | | |
|---|-------------------------------------|-------------------------|-------------------------|-------------------------|-------------------------|---------------------------|-------------------------|-------------------------|
| | 1325 | 1336 | 1632 | 1640 | 2128 | 2132 | 2136 | 2142 |
| Working Area Dimensions Çalışma Alanı Ölçüleri Mediciones del Area de Trabajo | 1300x2500 mm 51x98" | 1300x3700 mm 51x145" | 1600x3200 mm 63x126" | 1600x4000 mm 63x157" | 2100x2800 mm 83x110" | 2100x3200 mm 83x126" | 2100x3700 mm 83x145" | 2100x4200 mm 83x165" |
| Z Axis Distance Z Eksen Ölçüleri Z-As Abstand | 200 mm 7.87" | | | | | | | |
| Axis Speed Eksen Hızları Las Velocidades del eje | 80-80-20 m/min 3149-3149-787 IPM | | | | | | | |
| Spindle Motor Power Spindle Motor Gücü Spilmotorvermogen | 9 kW HSK F63 12HP HSK F63 | | | | | | | |
| Boring Unit Çoklu Delik Ünitesi Unidad de Agujeros Múltiples | 10 V (Std.) | | | | | | | |
| Rotary Magazin Unit Rotary Magazin Ünitesi Unidad de Herramientas | 8 Pcs 8 Adet | | | | | | | |
| CAD/CAM Program CAD/CAM Program Programa CAD/CAM | AES WOP | | | | | | | |
| Vacuum Zone Vakum Bölgesi Zona de Vacio | 2 | 4 | 6 | | 8 | | 10 | |
| Vacuum Pump Power Vakum Pompası Gücü Potencia de la bomba de vacio | 140 m³/h 5.4 HP | 250 m³/h 8.9 HP | 140 m³/h 5.4 HP | 250 m³/h 8.9 HP | | 2 x 50 m³/h 2 x 8.9 HP | | |
| Lift&Loading Unit Lift ve Yükleme Ünitesi Unidad de Elevacion y Carga | ✓ | | | | | | | |
| Unloading&Cleaning Unit Boşaltma Ve Temizleme Ünitesi Unidad de Descarga y Limpieza | ✓ | | | | | | | |
| Conveyor Unit Konveyör Ünitesi Unidad de Cinta Transportadora | ✓ | | | | | | | |

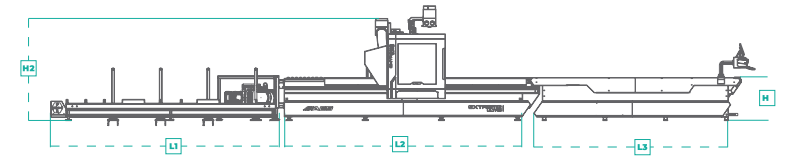
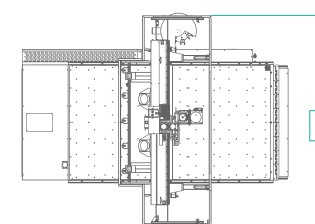
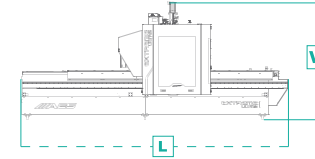

| DIMENSIONS ÖLÇÜLER DIMENSIONES | L | W | H |
|--------------------------------------|-------------------------|---------------|--------------|
| EXTREME ULTRA 1325 | mm / inch 3670 / 144.49 | 3080 / 121.26 | 2775 / 109.2 |
| EXTREME ULTRA 1336 | mm / inch 4870 / 191.72 | 3080 / 121.26 | |
| EXTREME ULTRA 1632 | mm / inch 4370 / 172.05 | 3380 / 133.07 | |
| EXTREME ULTRA 1640 | mm / inch 5170 / 203.54 | 3380 / 133.07 | |
| EXTREME ULTRA 2128 | mm / inch 3970 / 156.30 | 3880 / 152.76 | |
| EXTREME ULTRA 2132 | mm / inch 4370 / 172.05 | 3880 / 152.76 | |
| EXTREME ULTRA 2136 | mm / inch 4870 / 191.73 | 3880 / 152.76 | |
| EXTREME ULTRA 2142 | mm / inch 5370 / 211.42 | 3880 / 152.76 | |

| DIMENSIONS ÖLÇÜLER DIMENSIONES | L | L1 | L2 | L3 | W | H1 | H2 |
|--------------------------------------|--------------------------|---------------|---------------|---------------|---------------|--------------|--------------|
| EXTREME ULTRA 1325 | mm / inch 9410 / 370.47 | 3005 / 118.31 | 3670 / 144.49 | 2375 / 107.68 | 3080 / 121.26 | 1130 / 44.49 | 2775 / 109.2 |
| EXTREME ULTRA 1336 | mm / inch 13010 / 512.20 | 4205 / 165.55 | 4870 / 191.73 | 3935 / 154.92 | | | |
| EXTREME ULTRA 1632 | mm / inch 11510 / 453.15 | 3705 / 145.87 | 4370 / 172.05 | 3435 / 135.24 | 3380 / 133.07 | | |
| EXTREME ULTRA 1640 | mm / inch 13910 / 547.64 | 4505 / 177.36 | 5170 / 203.54 | 4235 / 166.73 | | | |
| EXTREME ULTRA 2128 | mm / inch 10310 / 405.91 | 3305 / 130.12 | 3970 / 156.30 | 3035 / 119.49 | 3880 / 152.76 | | |
| EXTREME ULTRA 2132 | mm / inch 11510 / 453.15 | 3705 / 145.87 | 4370 / 172.05 | 3435 / 135.24 | | | |
| EXTREME ULTRA 2136 | mm / inch 13010 / 512.20 | 4205 / 165.55 | 4870 / 191.73 | 3935 / 154.92 | | | |
| EXTREME ULTRA 2142 | mm / inch 14510 / 571.26 | 4705 / 185.24 | 5370 / 211.42 | 4435 / 174.61 | | | |

* The technical specifications and drawings provided in the catalogue are non-binding. Stock images and drawings may contain optional equipment. AES Group reserves the right to make amendments without notice.
 * Katalogda bulunan teknik özellikler ve çizimler bağlayıcı değildir. Bazı fotoğraflar ve çizimler opsiyonel ekipmanları içerebilir. AES Group bilgilendirme yapmaksızın değişiklik yapma hakkını saklı tutmaktadır
 * Las especificaciones técnicas y dibujos del catálogo no son vinculantes. Algunas fotos y dibujos pueden incluir equipamientos opcionales. Grupo AES se reserva el derecho de realizar cambios sin previo aviso.

ALWAYS WITH YOU

DAİMA YANINIZDA

SIEMPRE CON USTED

EN

Our expert after-sales service staff is 24/7 at your service for all your needs. For your permanent satisfaction, it provides an accurate diagnosis and intervention to all your problems as soon as possible with both instant remote connection support and on-site service. AES GROUP protects your investments with after-sales services for uninterrupted production.

TR

Uzman satış sonrası hizmet kadromuz, tüm ihtiyaçlarınız için 7 gün 24 saat hizmetinizdedir. Daimi memnuniyetiniz için, gerek anlık uzak bağlantı desteği ile gerekse de yerinde servis hizmeti ile en kısa sürede, tüm sorunlarınıza doğru teşhis sağlayarak müdahale sağlamaktadır. AES GROUP, kesintisiz üretim yapmanız için sunduğu satış sonrası hizmetler ile yatırımlarınızı korur.

ES

Nuestro experto personal de servicio posventa está a su servicio las 24 horas del día, los 7 días de la semana para todas sus necesidades. Para su satisfacción permanente, brinda un diagnóstico preciso e intervención a todos sus problemas a la mayor brevedad posible con soporte instantáneo de conexión remota y servicio en el sitio. GRUPO AES protege sus inversiones con servicios postventa para una producción ininterrumpida.



REMOTE AND ON-SITE SERVICE SERVICES

UZAKTAN VE YERİNDE SERVİS HİZMETLERİ

SERVICIOS DE MANDO A DISTANCIA Y LUGAR



TRAINING AND INSTALLATION SERVICES

EĞİTİM VE KURULUM HİZMETLERİ

SERVICIOS DE FORMACIÓN E INSTALACIÓN



SPARE PARTS AND SALES SUPPORT

YEDEK PARÇA VE SATIŞ DESTEĞİ

PIEZAS DE RECAMBIO Y SOPORTE DE VENTA



UNINTERRUPTED CONNECTION WITH WEB PLATFORM

WEB PLATFORMU İLE KESİNTİSİZ BAĞLANTI

CONEXIÓN PERMANENTE CON LAS PLATAFORMA WEB



24/7 0850 22 77 AES
CALL CENTER
CENTRO DE LLAMADAS

CNC MACHINING CENTER (FLAT TABLE GROUP)

CNC İŞLEME MERKEZİ (DÜZ TABLA GRUBU)

CENTRO DE PROCESAMIENTO CNC (GRUPO DE PLATAFORMA PLANA)

ULTRA
SERIES U



▪ RAPTOR ULTRA



▪ EXTREME ULTRA

PRO
SERIES P

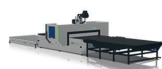

▪ SUPER NOVA



▪ FLEXA PRO

CNC MACHINING CENTER (CONSOLE TABLE GROUP)

CNC İŞLEME MERKEZİ (KONSOL TABLA GRUBU)

CENTRO DE PROCESAMIENTO CNC (GRUPO DE PLATAFORMA DE CONSOLAS)

ULTRA
SERIES U



▪ VEGA ULTRA 5X



▪ VEGA ULTRA

PRO
SERIES P



▪ VEGA 5X PRO

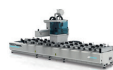

▪ VEGA PRO

CNC DRILLING MACHINES

CNC DELİK MAKİNELERİ

MÁQUINAS DE AGUJERO CNC

ULTRA
SERIES U



▪ GO! ULTRA

PRO
SERIES P



▪ GO! 1300
▪ GO! 1300 M/S
▪ GO! 1300 M/S ATC



▪ SIRIUS 950
▪ SIRIUS 950 M/S
▪ SIRIUS 950 M/S ATC

BEAM SAW MACHINES

PANEL EBATLAMA MAKİNELERİ

SECCIONADORAS

ULTRA
SERIES U



▪ ALPHA PS 05
▪ ALPHA PS 06



▪ ALPHA PS 03
▪ ALPHA PS 04

PRO
SERIES P



▪ BETA PS 03
▪ BETA PS 04

EDGE BANDING MACHINES

KENAR BANTLAMA MAKİNELERİ

CANTEODORAS MONOLATERALES AUTOMÁTICAS

ULTRA
SERIES U



▪ GAMMA ULTRA

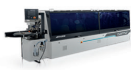

▪ GAMMA MX

PRO
SERIES P

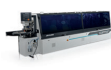

▪ PRIMA 6M
▪ PRIMA 5M

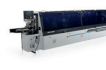

▪ GAMMA 7M
▪ GAMMA 6M

PRODUCTS GROUP

ÜRÜN GRUPLARIMIZ

GRUPO DE PRODUCTOS

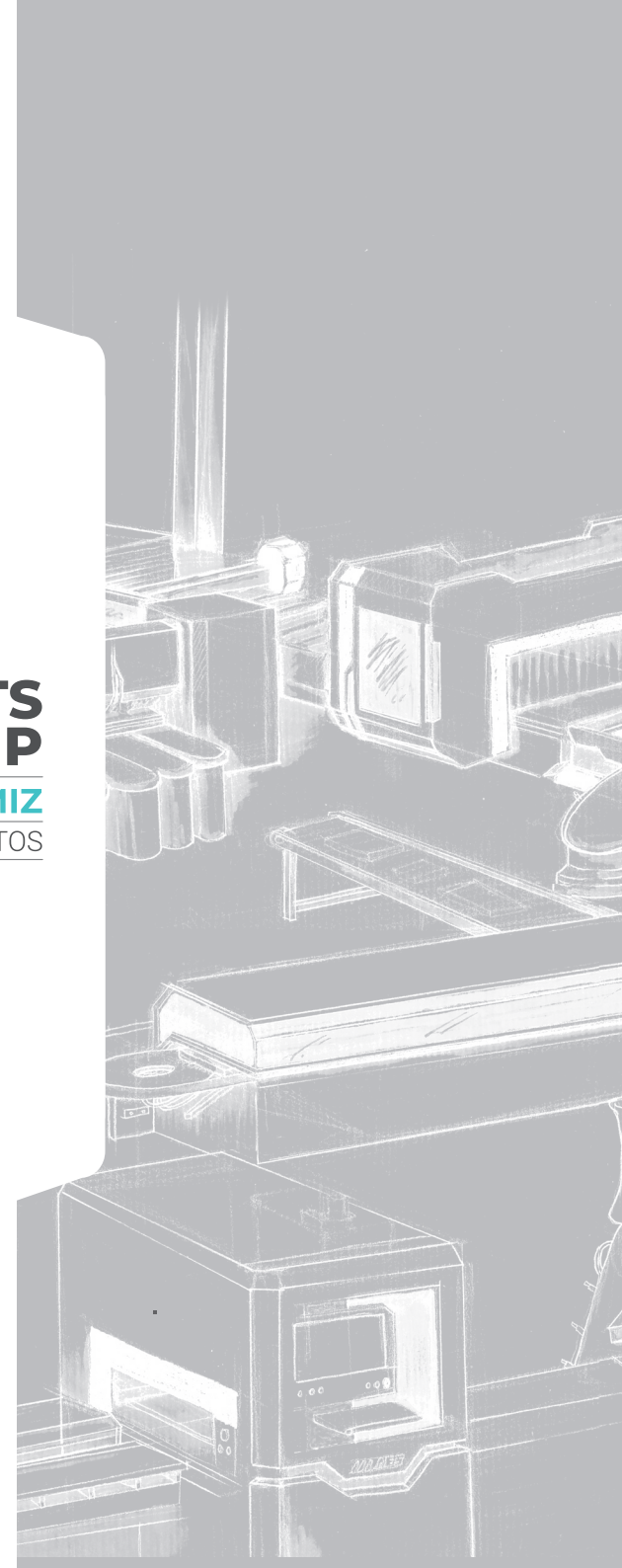

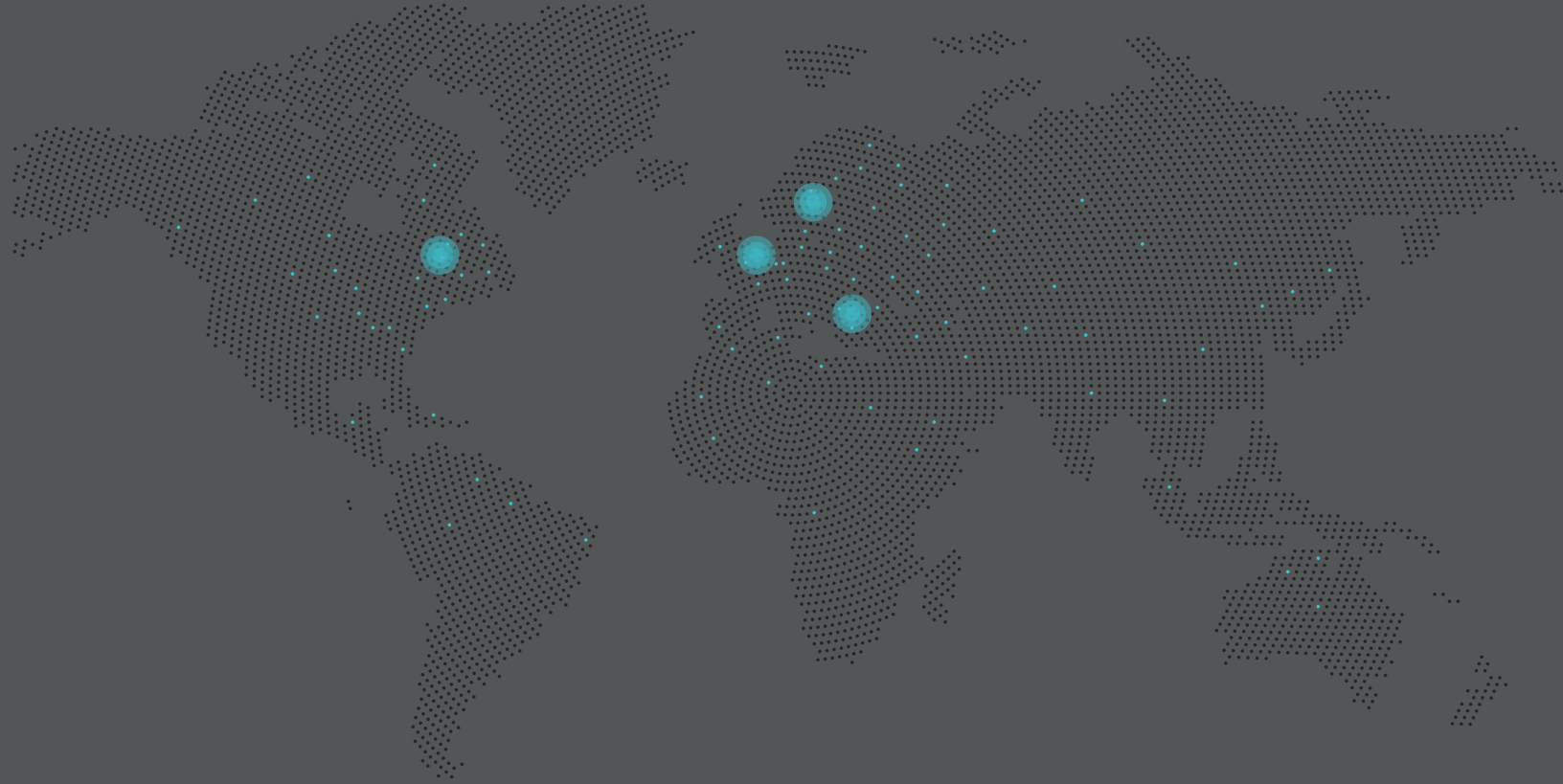

AES HEADQUARTER

NOSAB Şeftali Cd.
118. Sk. No:4 Nilüfer
16140 Bursa / TÜRKİYE

Tel : +90 224 443 33 90
Fax : +90 224 443 29 65

info@aesgroup.com.tr
www.aesgroup.com.tr



AES EUROPE BVBA

Kruisbosstraat
2b2-6186, 3740
Bilzen / BELGIUM

Tel : +32 89 81 1505
Fax : +32 89 81 1505

info@aesgroupeurope.com
www.aesgroupeurope.com



AES AMERICA INC.

4508-B Westinghouse
Blvd.Charlotte, 28273
NC USA

Tel : +1 704 817 7037
Fax : +1 704 817 7036

info@aesgroupamerica.com
www.aesgroupamerica.com



AES GROUP MACHINERY UK LTD

Unit 6, Dakota Business Park, Dakota
Way, Burscough, Lancashire L40 8AF
UNITED KINGDOM

Tel : +44 800 083 8844
Fax : +44 800 083 8855

info@aesgroupukmachinery.co.uk
www.aesgroupukmachinery.co.uk



www.aesgroup.com.tr